

HT200

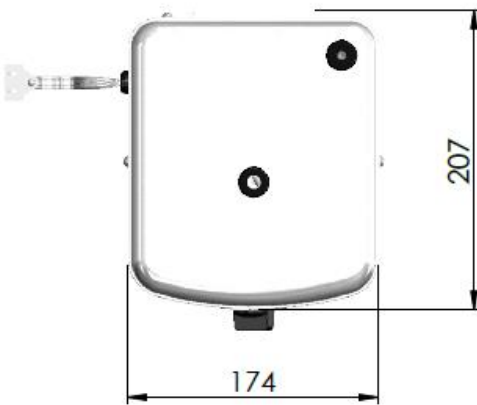

UNIT : mm