

DF3010

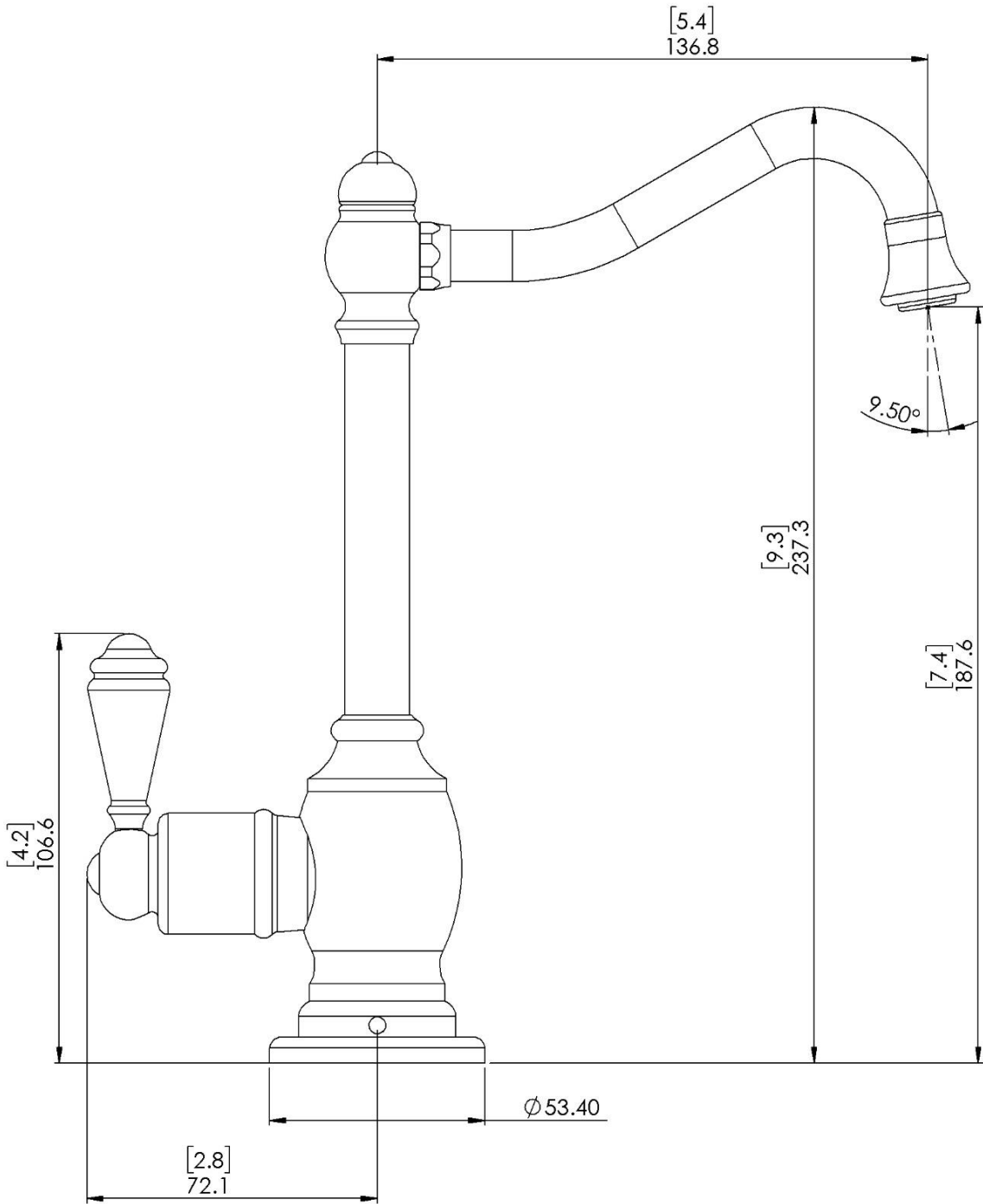

UNIT : $\frac{[inch]}{mm}$