

DF3003

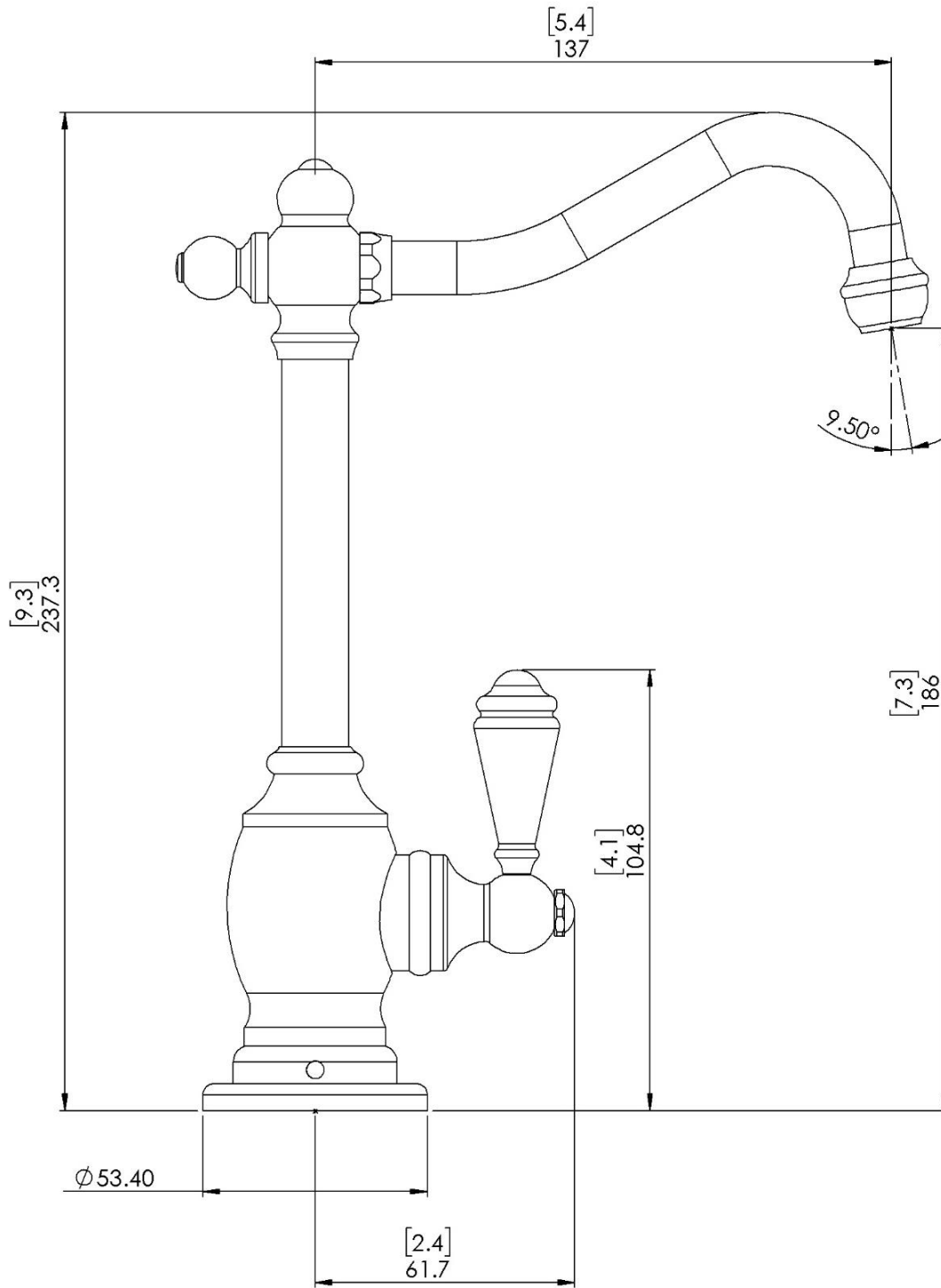

UNIT : $\frac{[inch]}{mm}$