

# DF3001

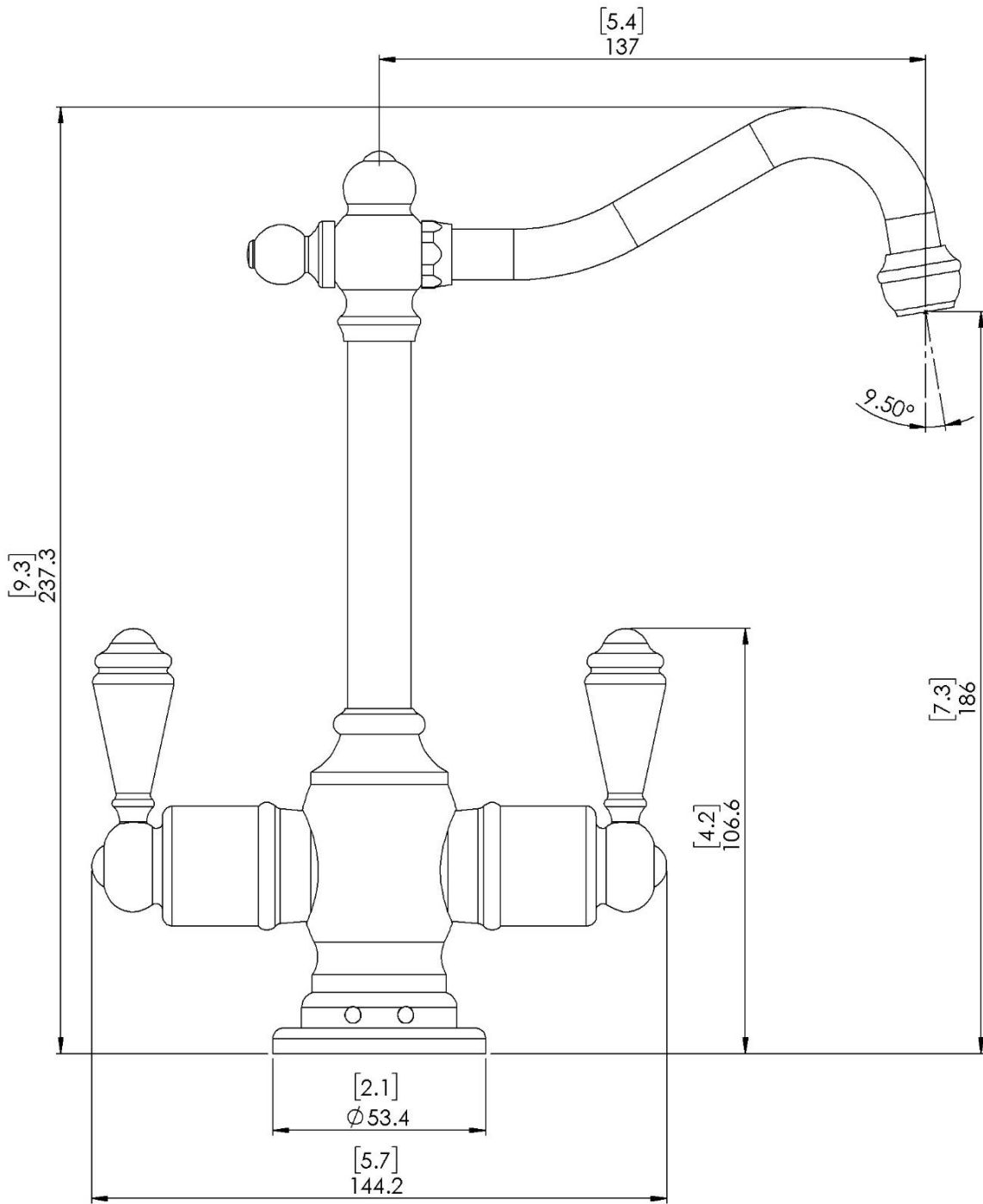

UNIT :  $\frac{[inch]}{mm}$