

DF5001

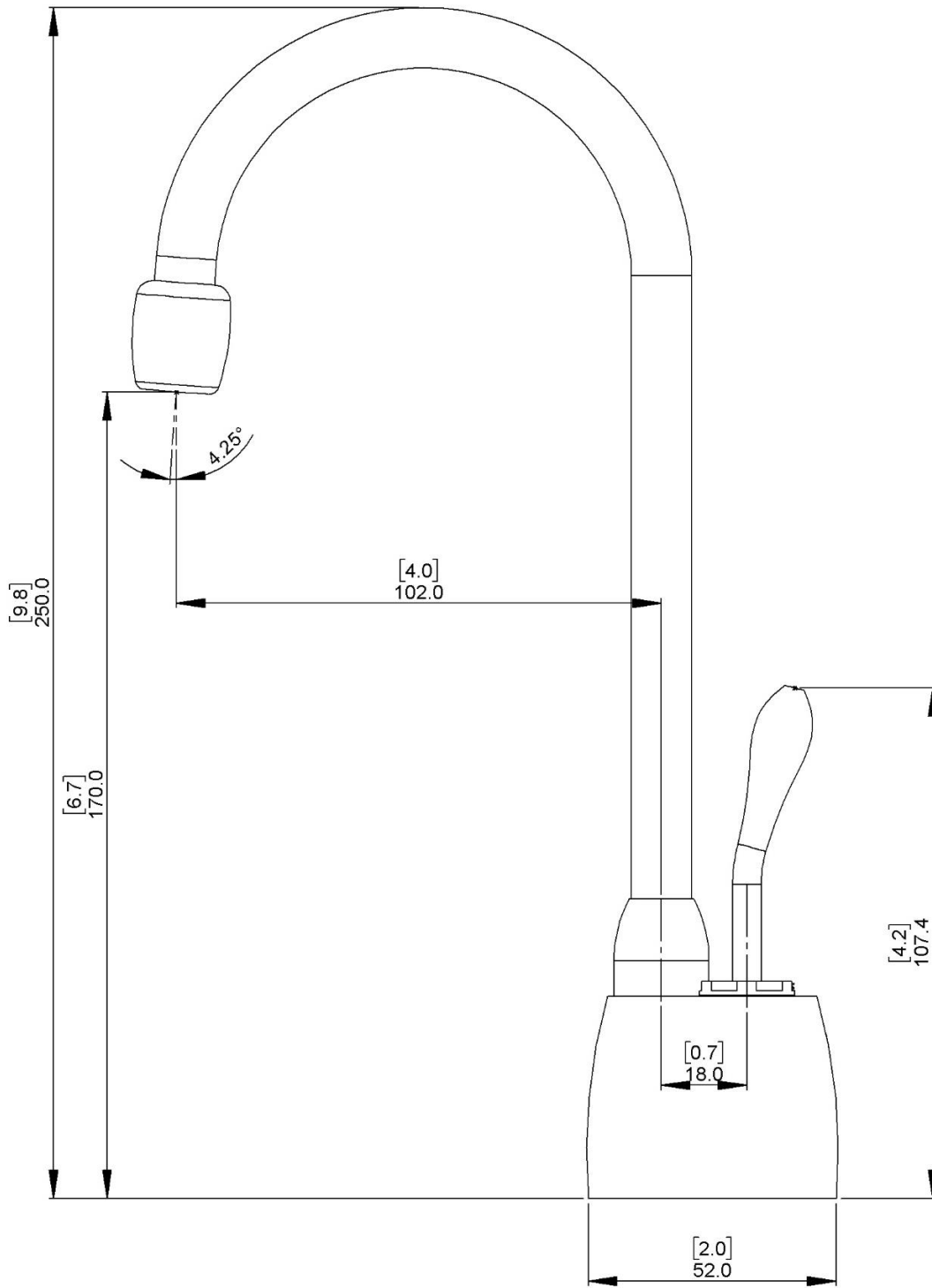

UNIT: $\frac{[\text{inch}]}{\text{mm}}$