

DF5011

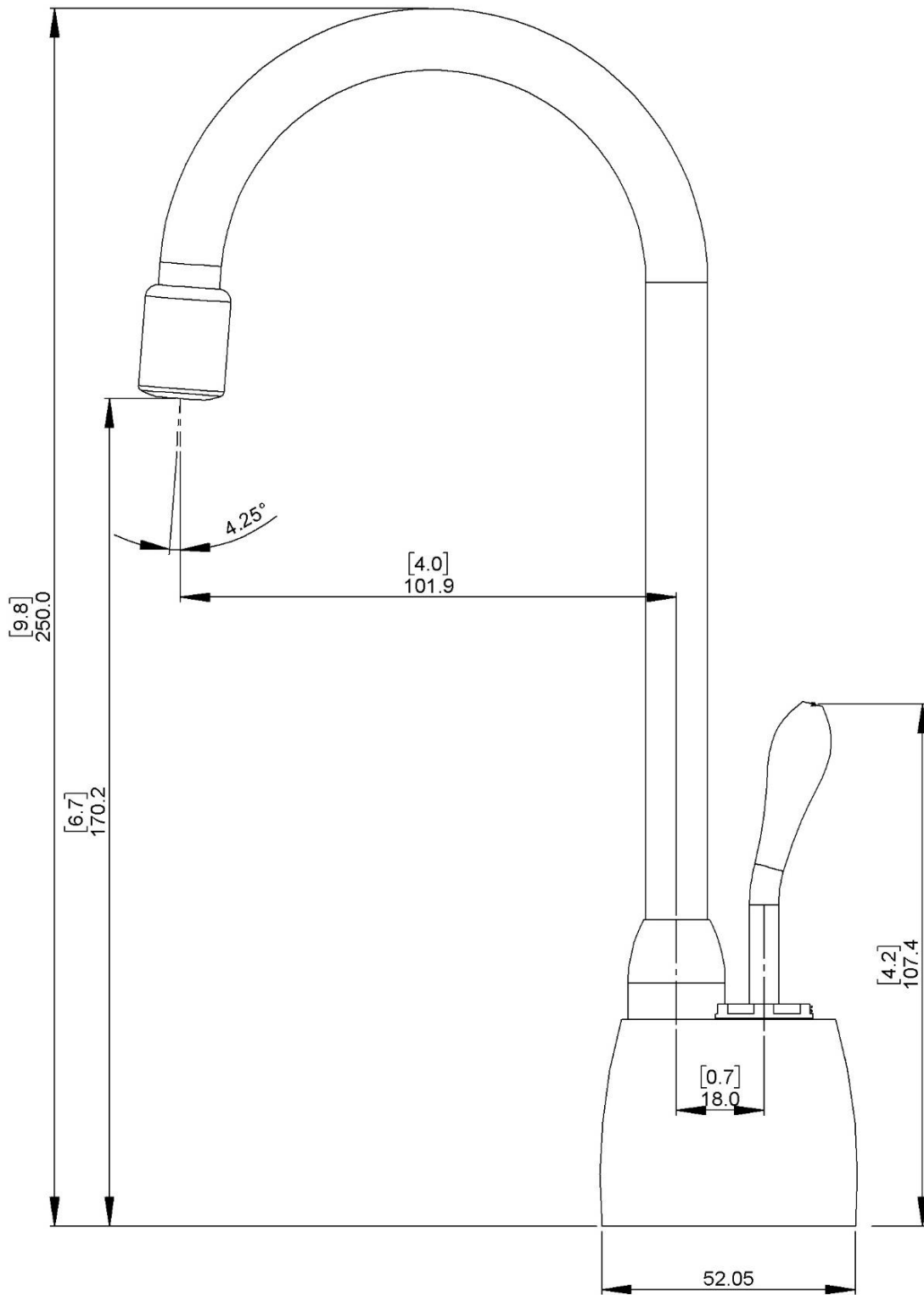

UNIT: $\frac{[inch]}{mm}$